



# DESENHO INDUSTRIAL

Susana Serrão Guimarães - 2005



# DESENHO INDUSTRIAL

O registro de desenho industrial só protege a forma do objeto.



# Registro

- Não há exame quanto à novidade;
- Poderá ser concedido em menos de 6 meses;
- As exigências técnicas saem, na íntegra, na RPI (Revista da Propriedade Industrial-patentes).

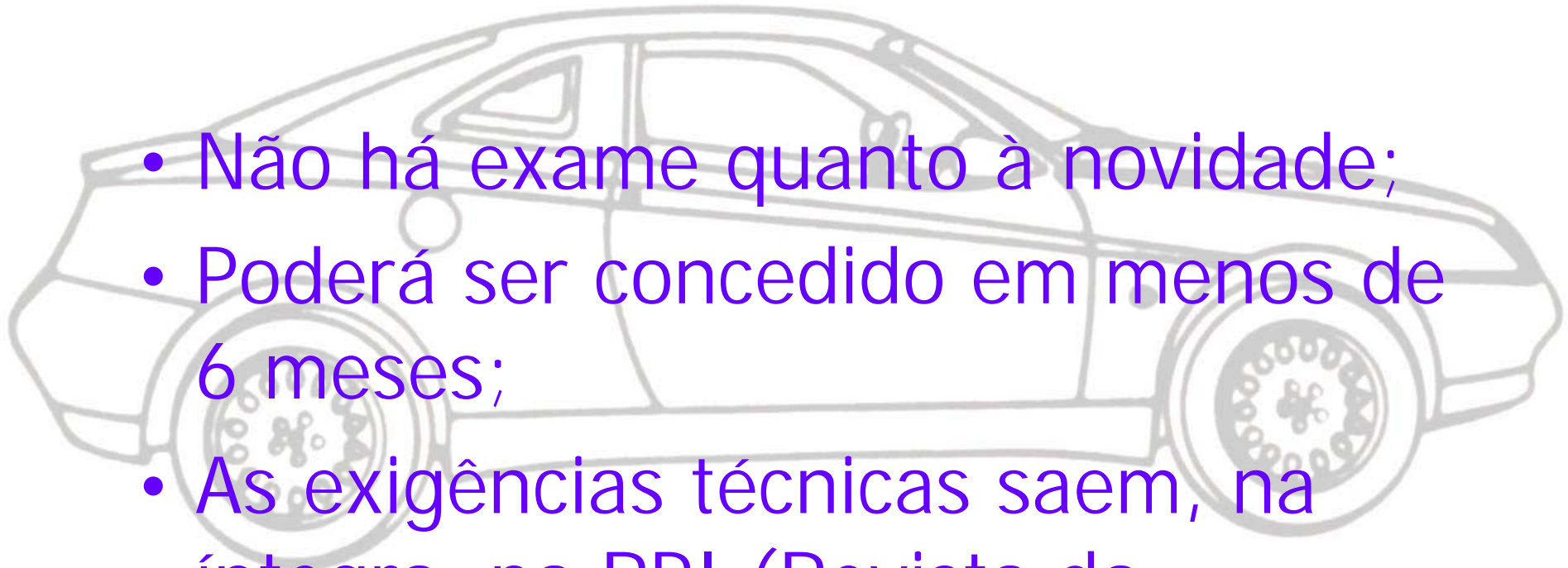

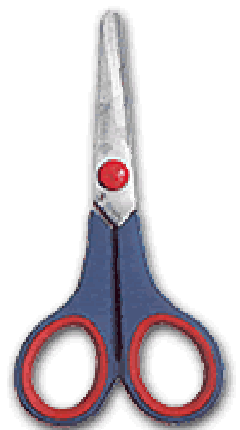

A natureza de registro de  
Desenho Industrial protege a  
forma externa do objeto, e  
não sua função prática







**KIDS  
MANIA**

& Eliana

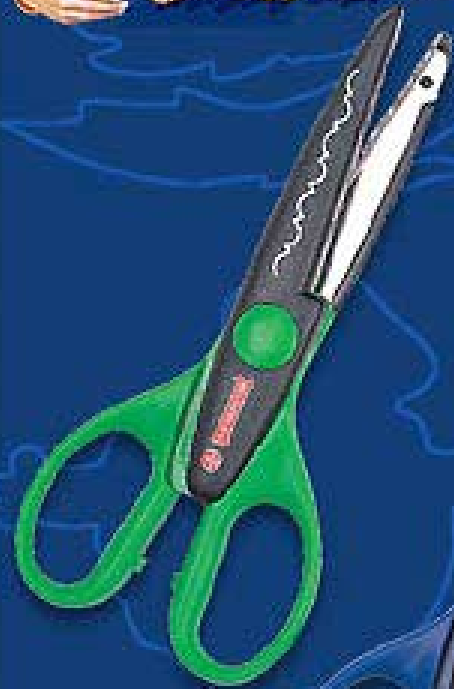



Para Diestros e Zurdos  
**PARA  
DESTROS E  
CANHOTOS**  
For Right and Left-Handed Users







 Think different.



**Se o que se pretende proteger é a forma do objeto, a natureza de proteção correta é a de Registro de Desenho Industrial.**



 Think different.



**Somente as  
características  
ornamentais serão  
consideradas.**



 Think different.



**Mas se o que se deseja  
requerer é o  
funcionamento do ajuste  
da posição da tela, o  
Registro de Desenho  
Industrial NÃO será a  
natureza correta de  
proteção.**

# Considera-se Desenho Industrial, todo produto industrial, ou um padrão ornamental.

- Produto Industrial é o objeto em sua forma tridimensional.



# Padrão Ornamental

- Entende-se por padrão ornamental: um conjunto de linhas e cores que possa ser aplicado em um produto.



# "Padrão Ornamental Aplicado à Carroceria de Ônibus"

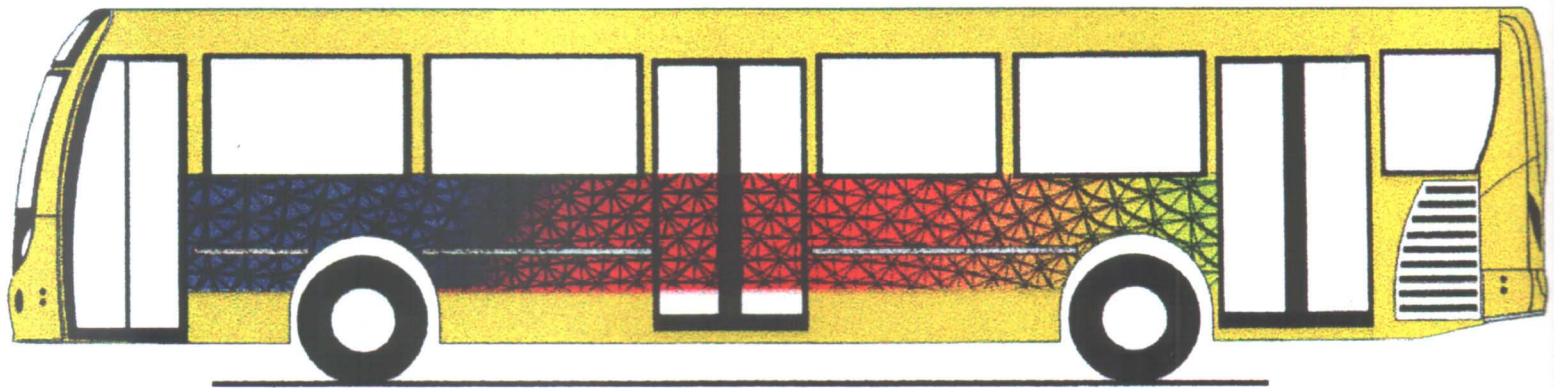

FIG. 1

“Padrão ornamental aplicado em relógio de pulso”





# Desenhos

- O Registro de DI protege a forma do objeto, portanto, são as figuras (desenhos ou fotografias) que caracterizam a proteção concedida.

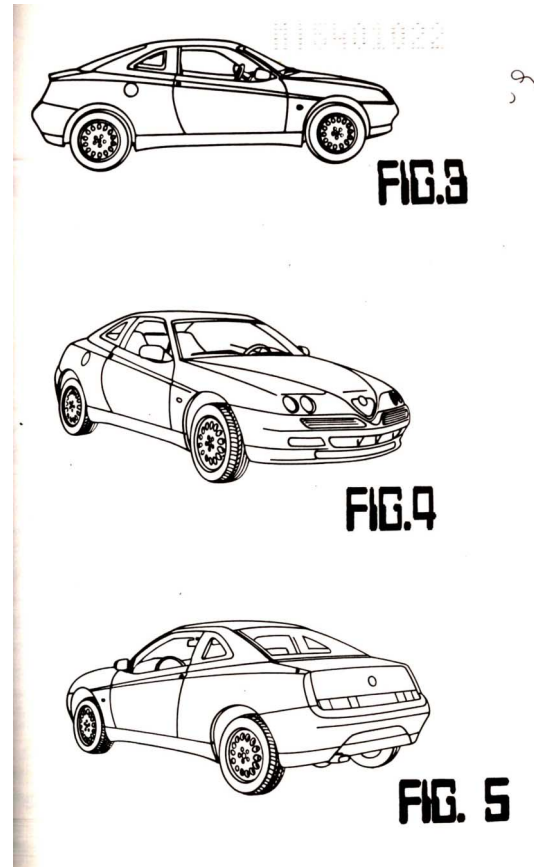

Vistas Necessárias  
para a apresentação  
de um pedido de  
registro de DI.

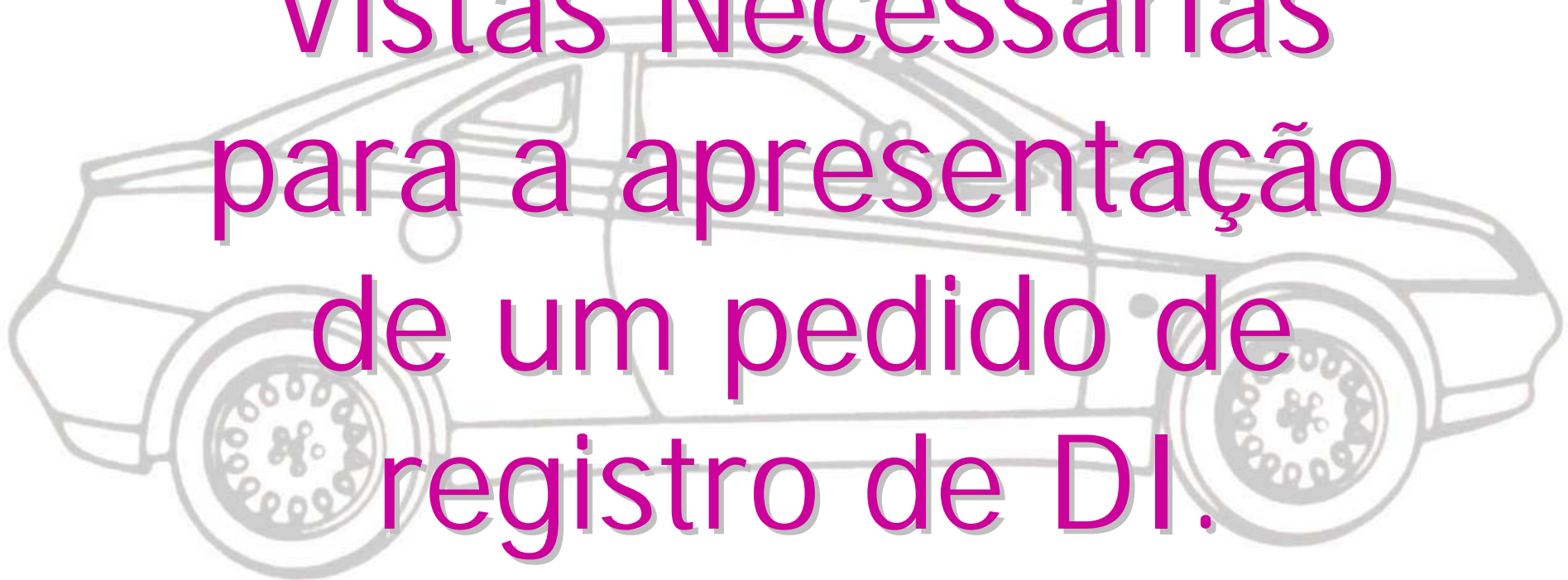

FIG. 01

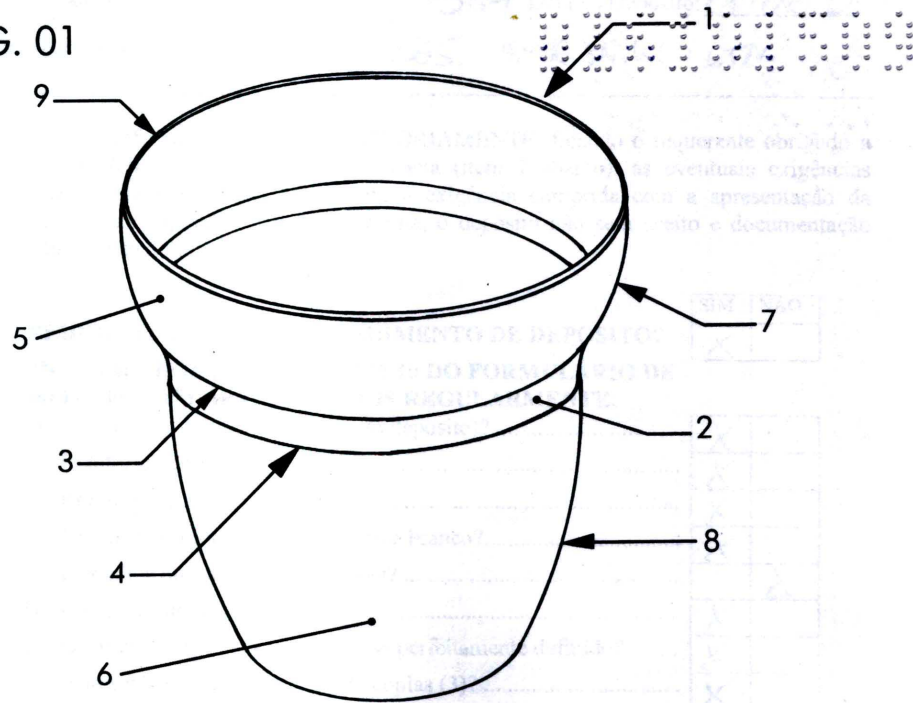

FIG. 02

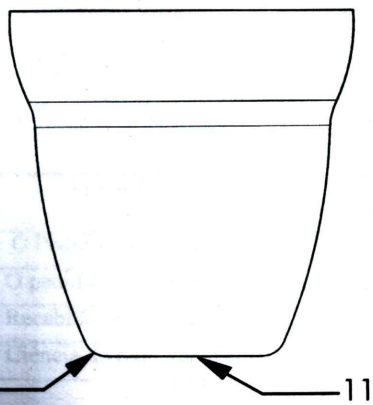
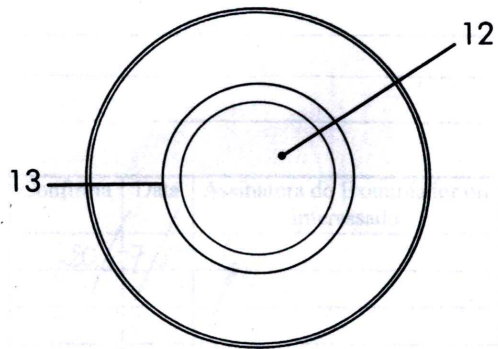

FIG. 03



# "Bolsa com Alças"



FIG.1



FIG.2



# Ato Normativo de DI

11.4.6. Os desenhos ou fotografias deverão ilustrar somente o objeto em sua forma montada, revelando apenas sua configuração externa, sem destacar detalhes e partes, separadamente.

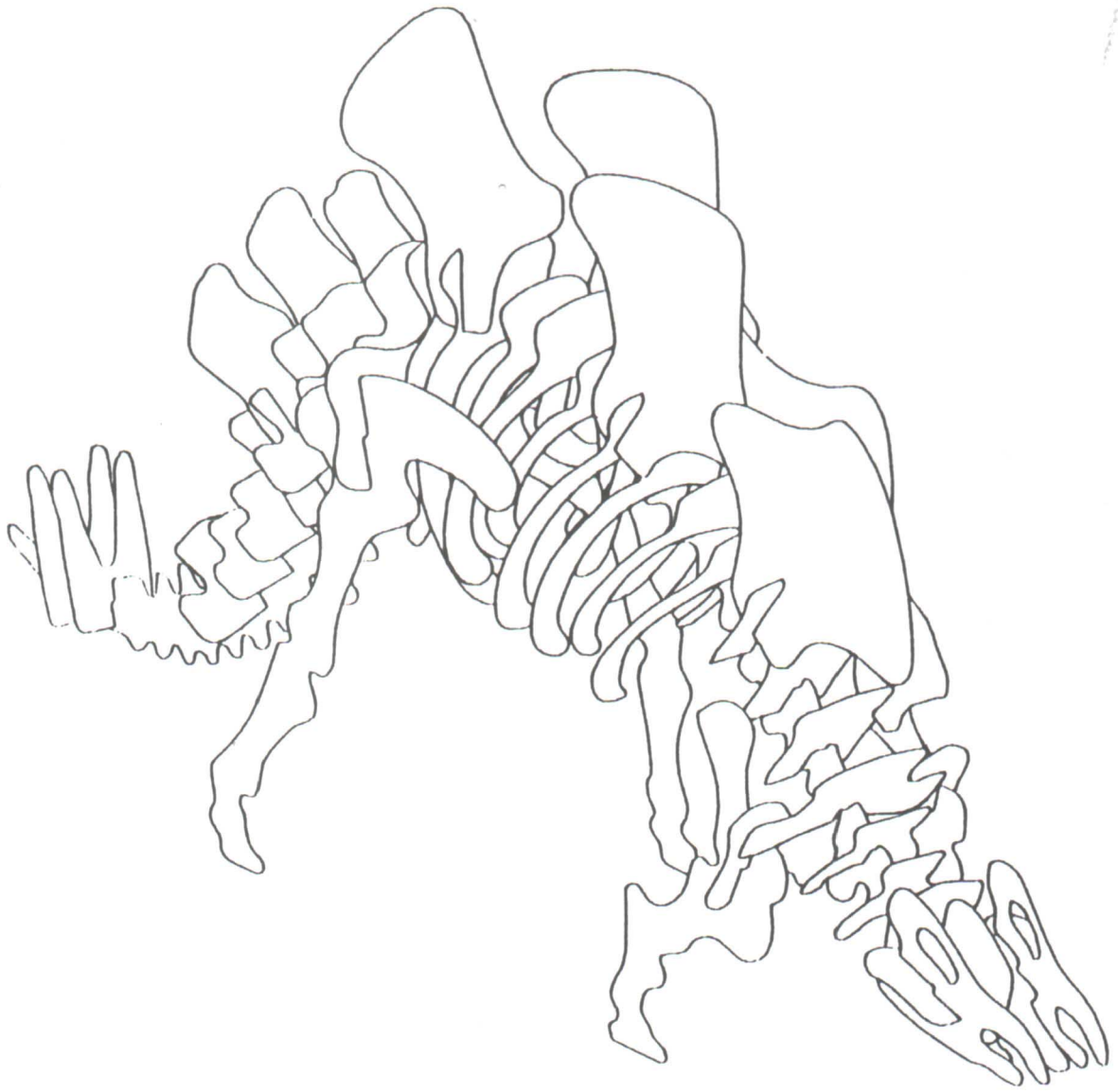



FIG. 03

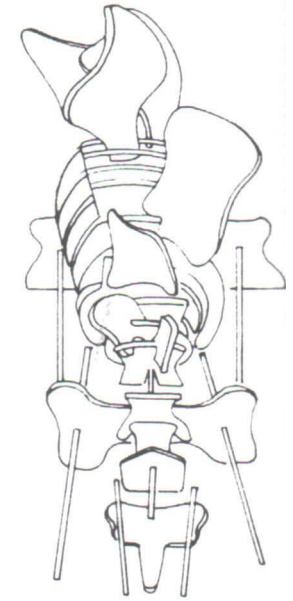
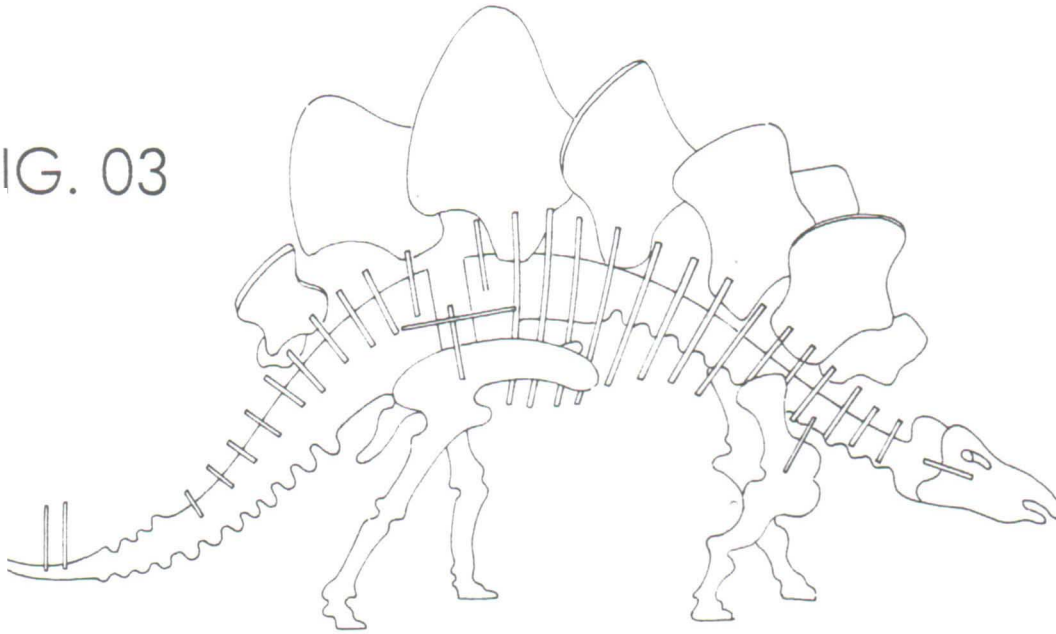
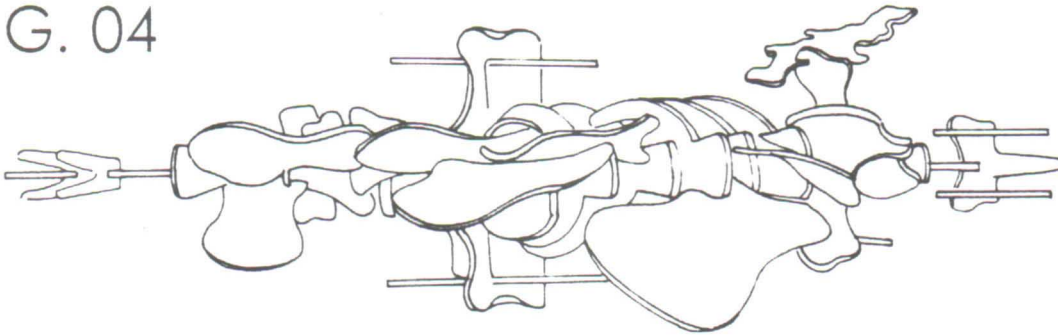

FIG. 02

FIG. 04



# Variantes Configurativas

O pedido de DI deverá referir-se a um único objeto, sendo permitidas até 20 variantes em um mesmo pedido. São consideradas variantes, aqueles objetos que contiverem pequenas modificações do produto original, sem prejudicar as características deste.



FIG. 5A

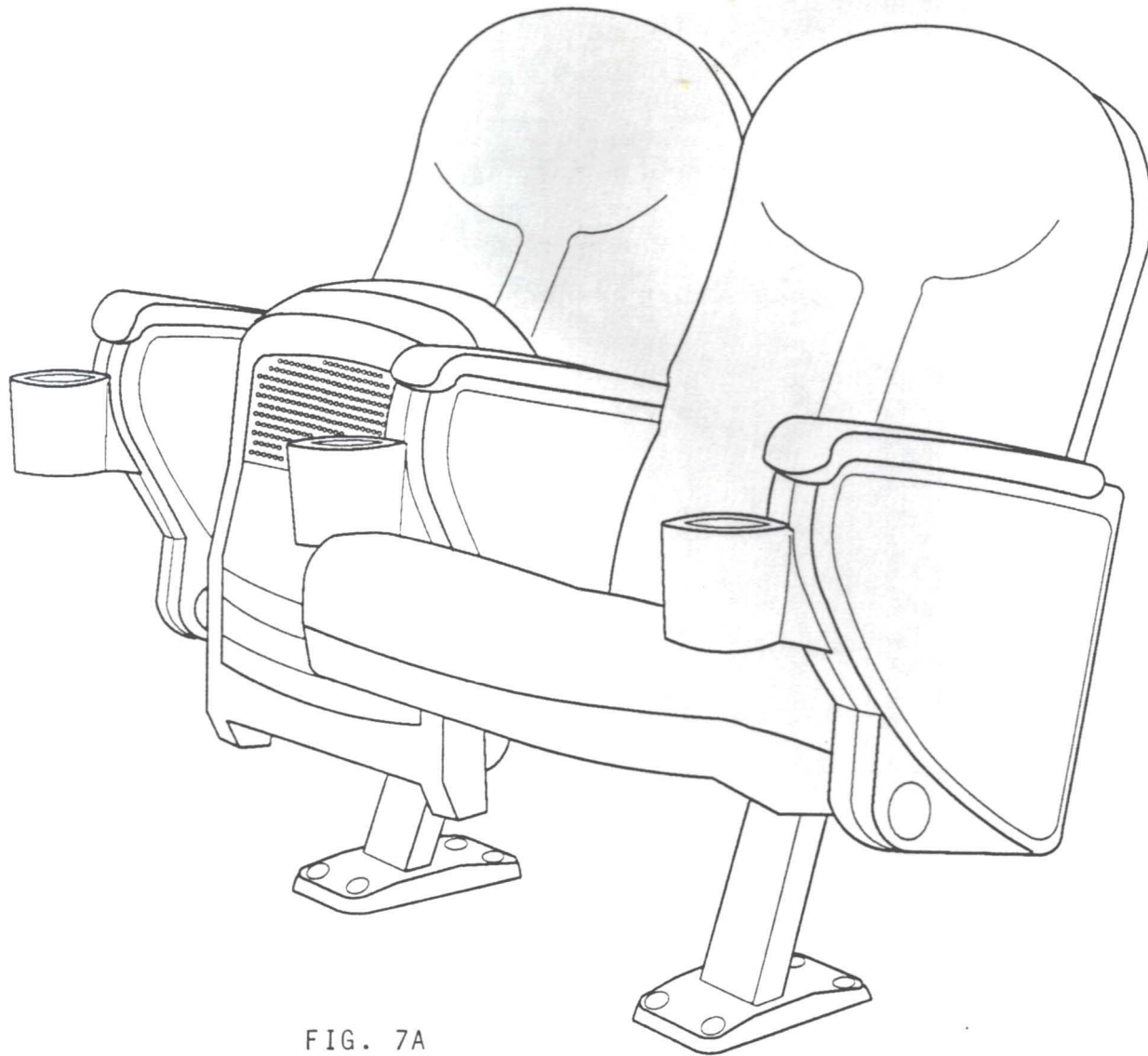

FIG. 7A

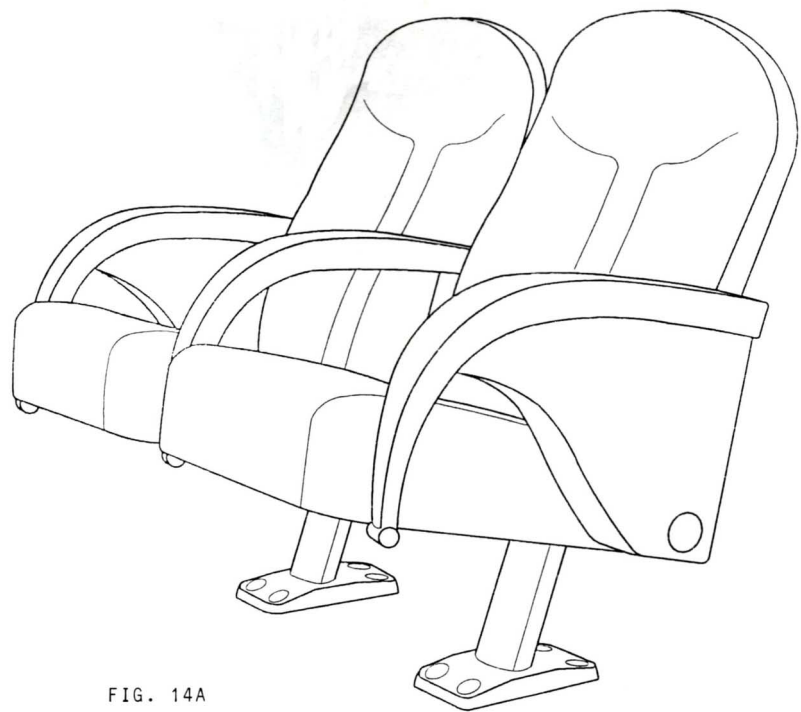

FIG. 14A

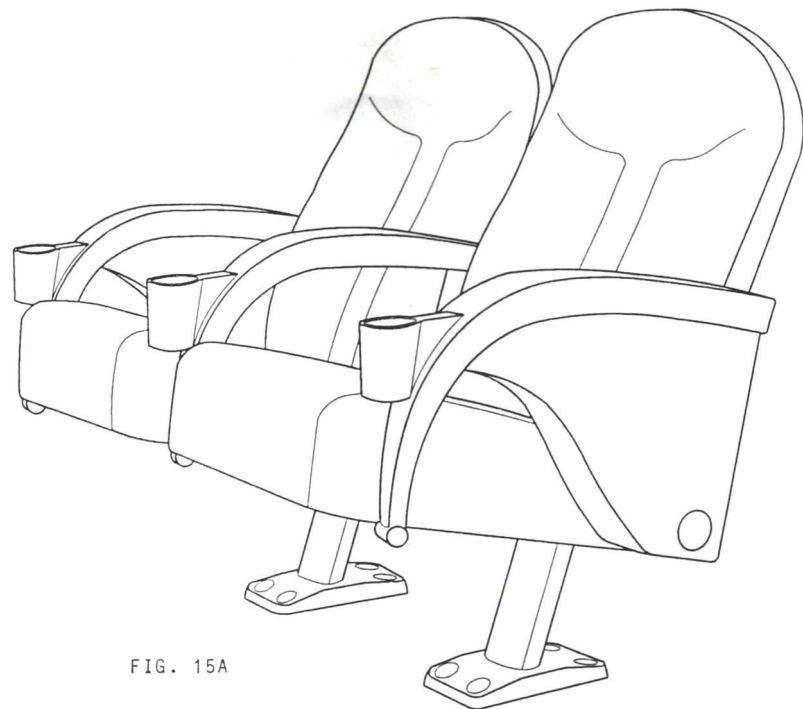

FIG. 15A

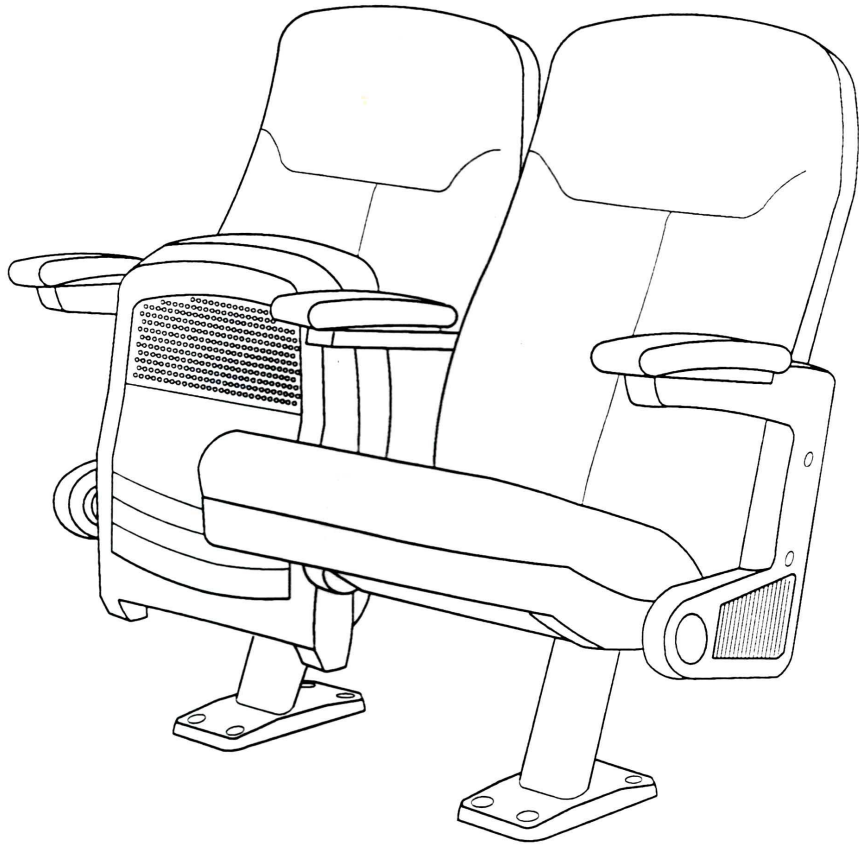

FIG. 1A

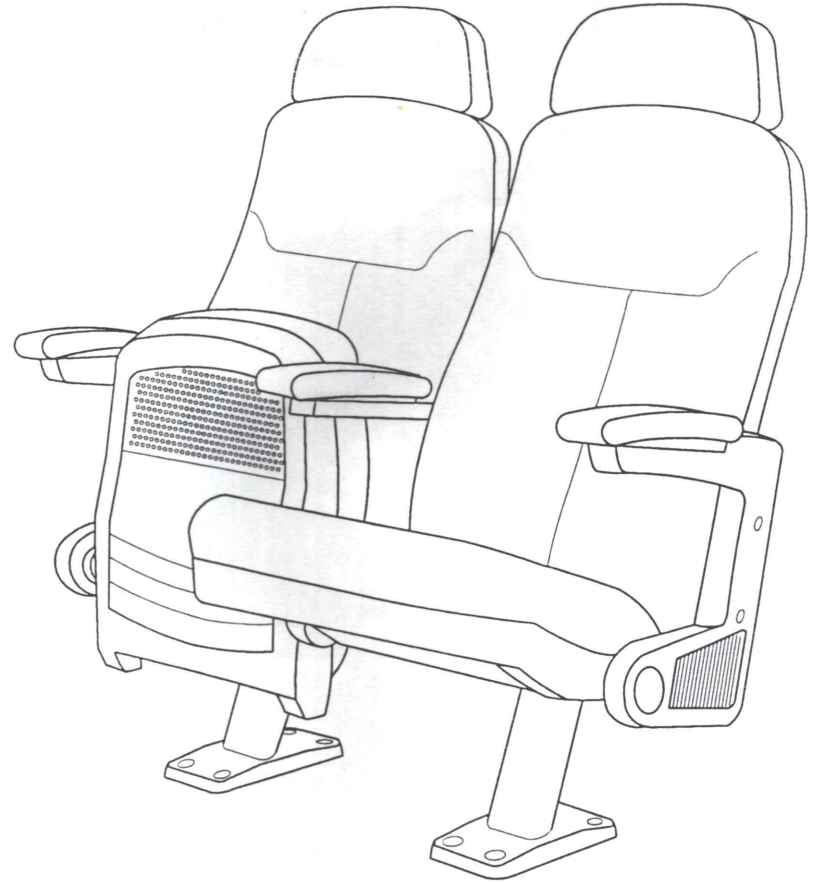

FIG. 4A

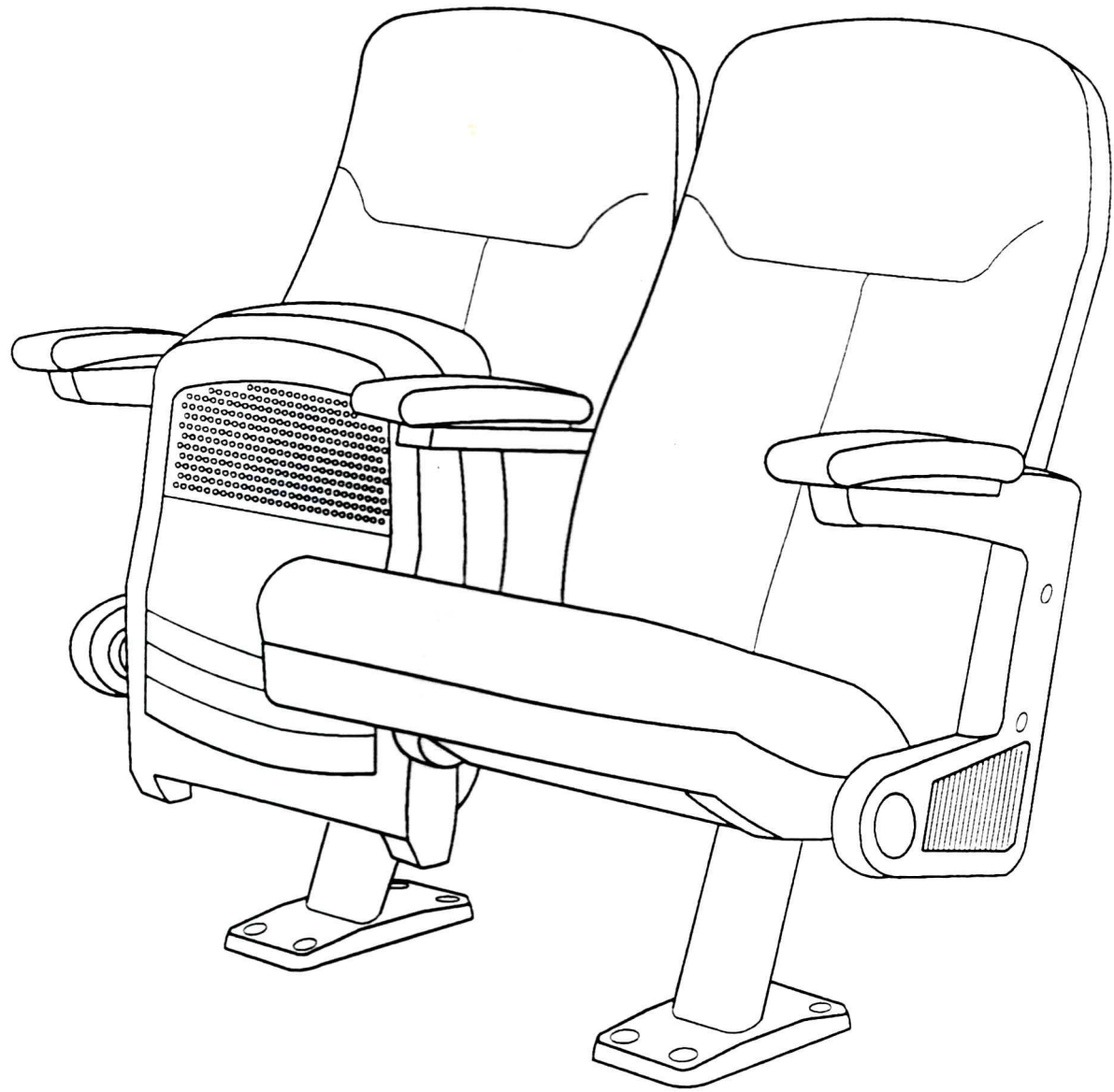

FIG. 1A

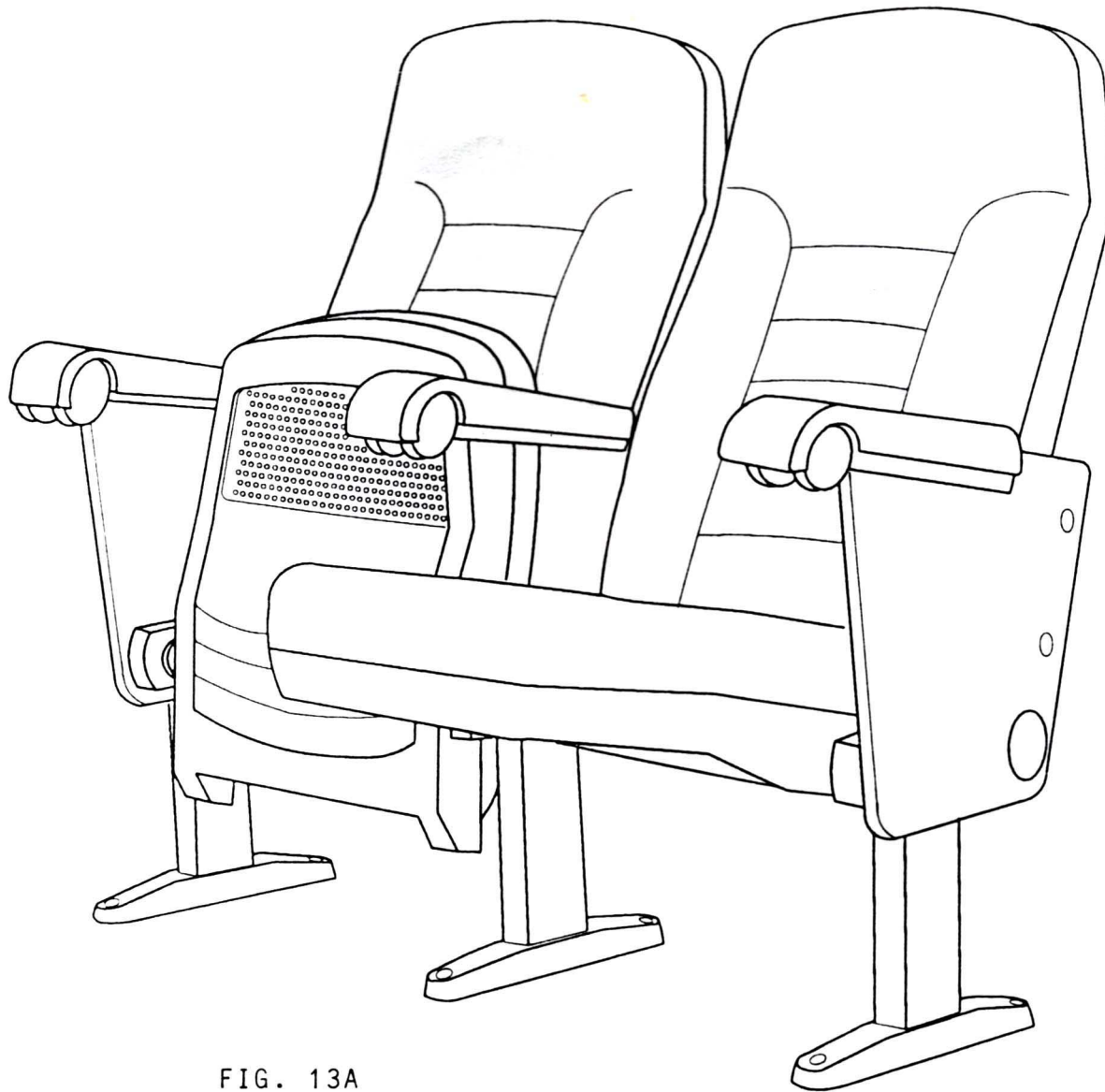

FIG. 13A





FIG. 5A

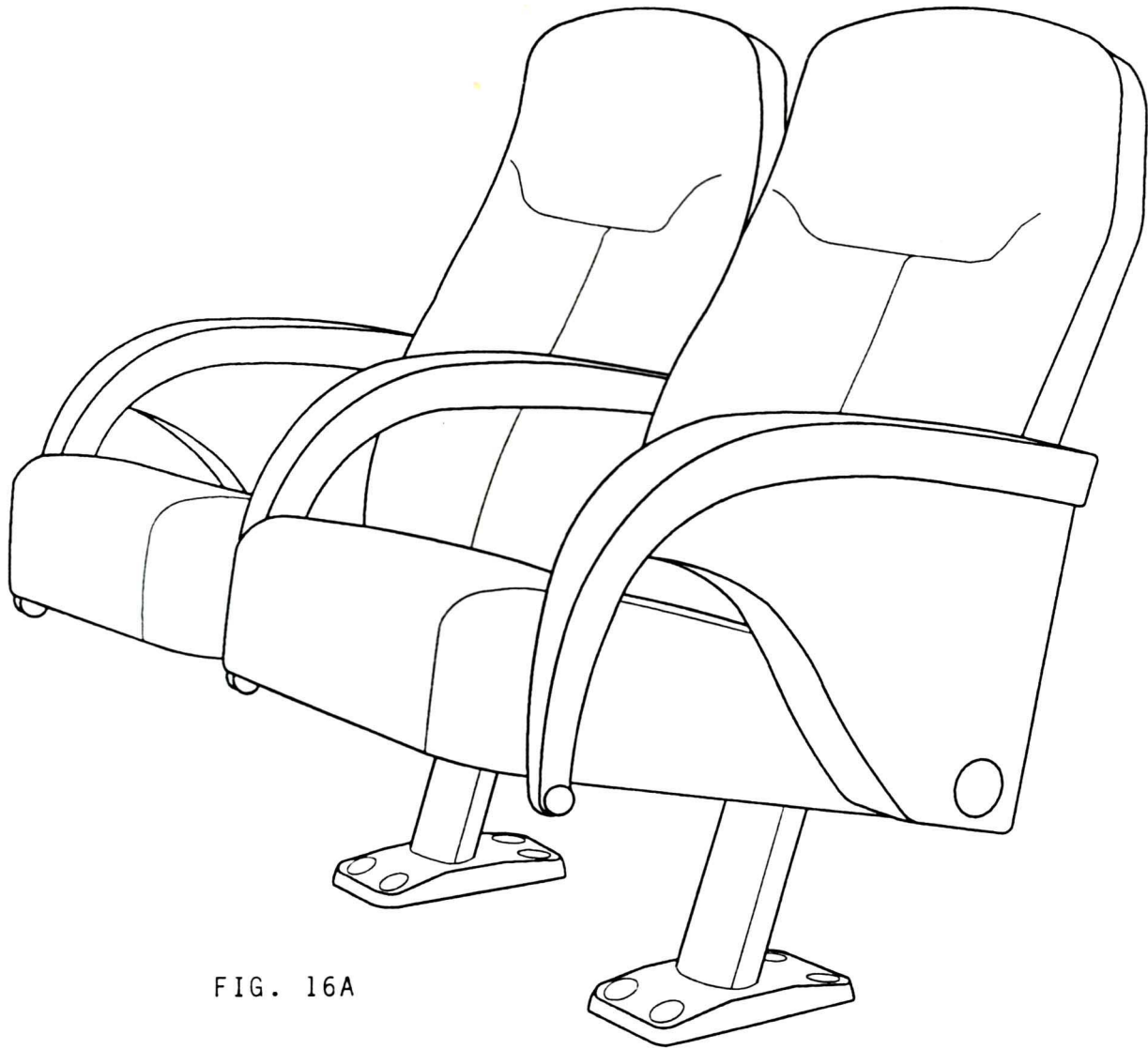

FIG. 16A

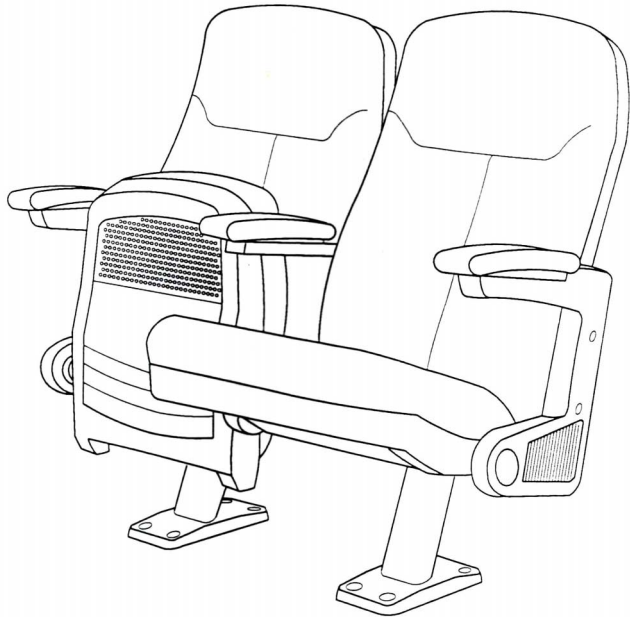

FIG. 1A

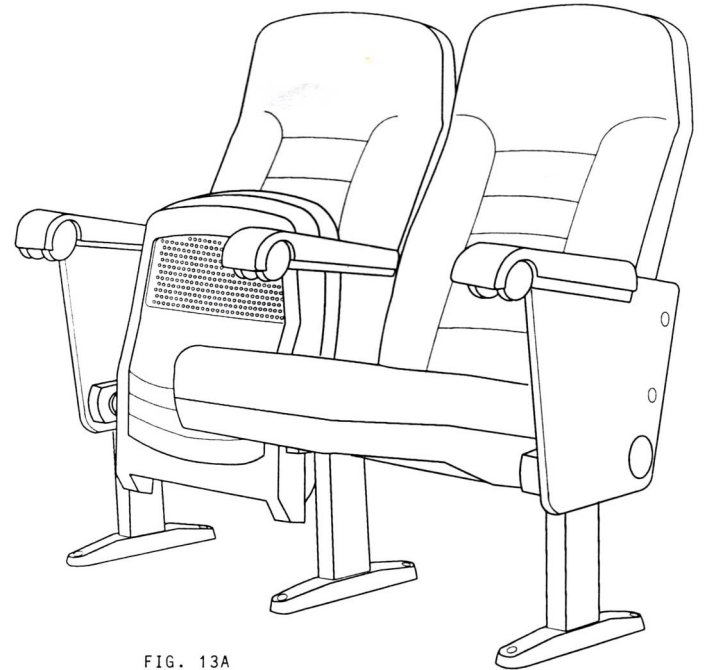

FIG. 13A



FIG. 5A

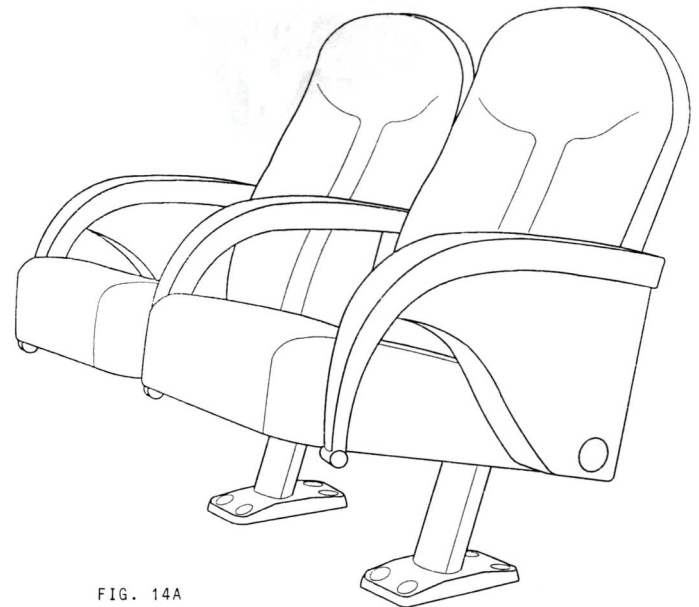

FIG. 14A

# Variante Configurativa

## Conjuntos







FIG. 02

FIG. 01

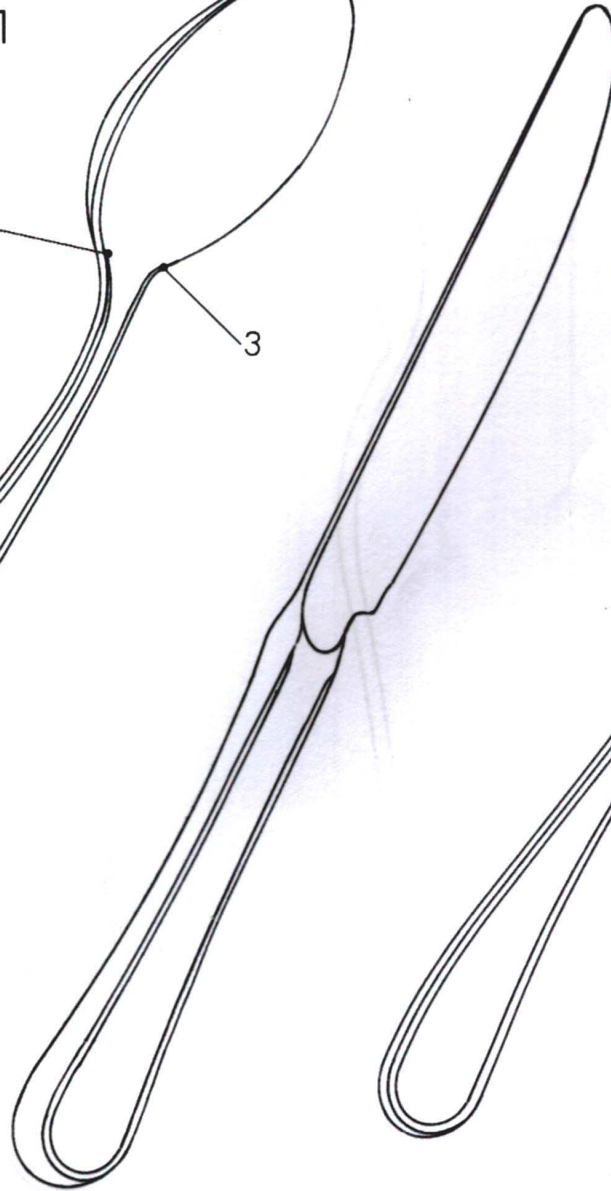
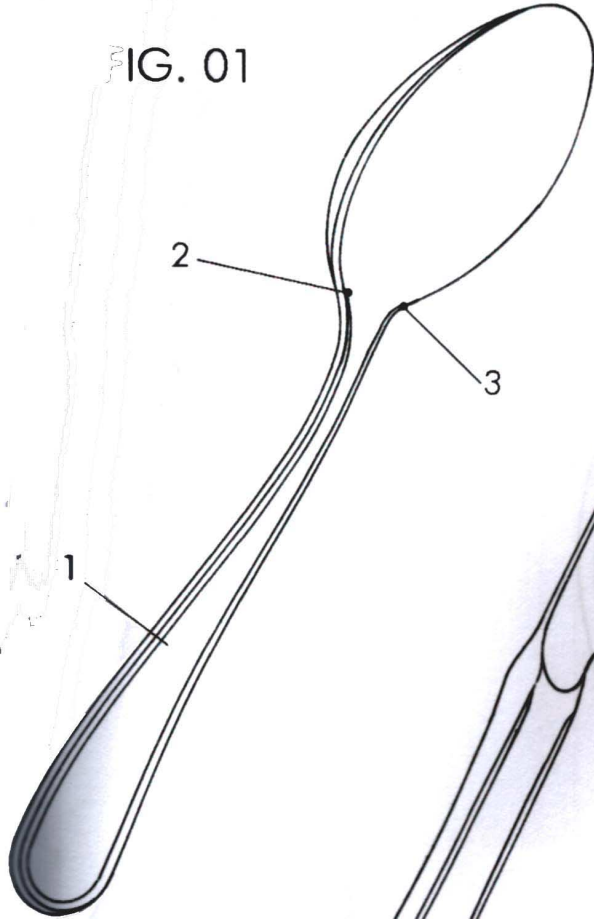

FIG. 03

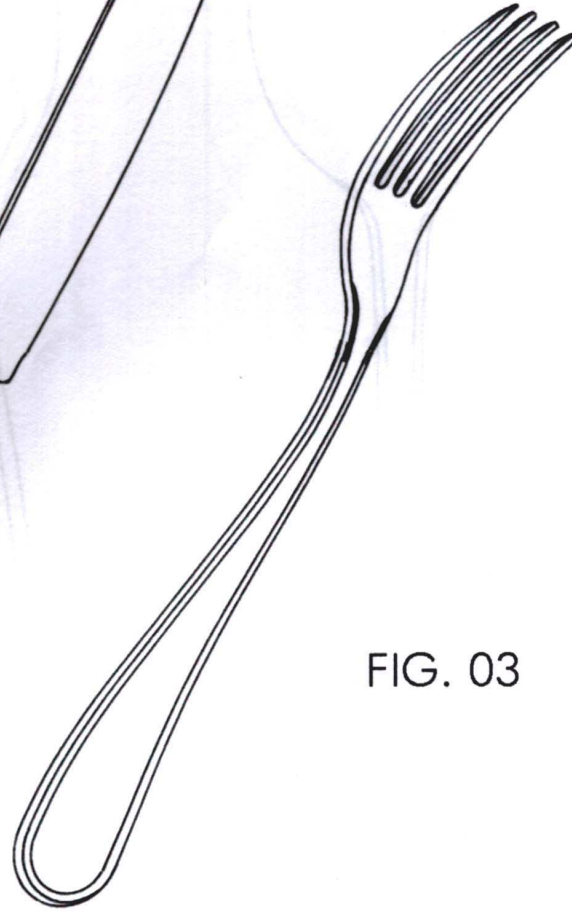

FIG. 04

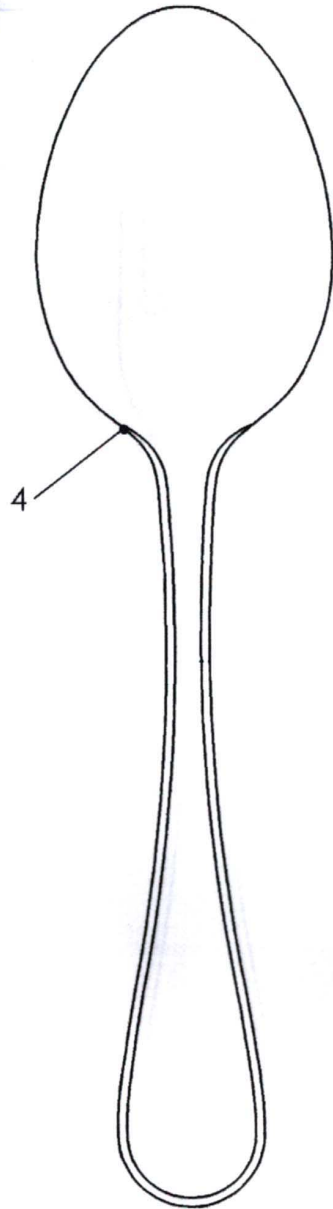

FIG. 05

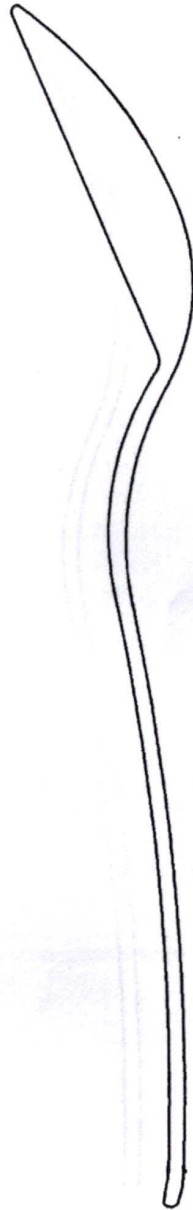

FIG. 06

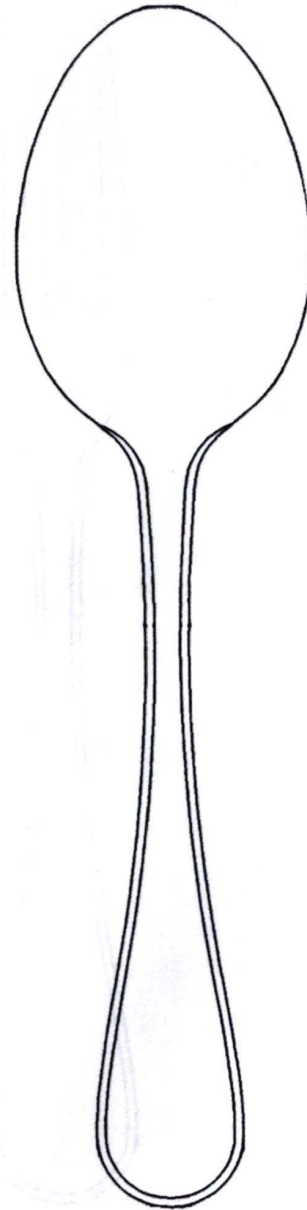



FIG. 10

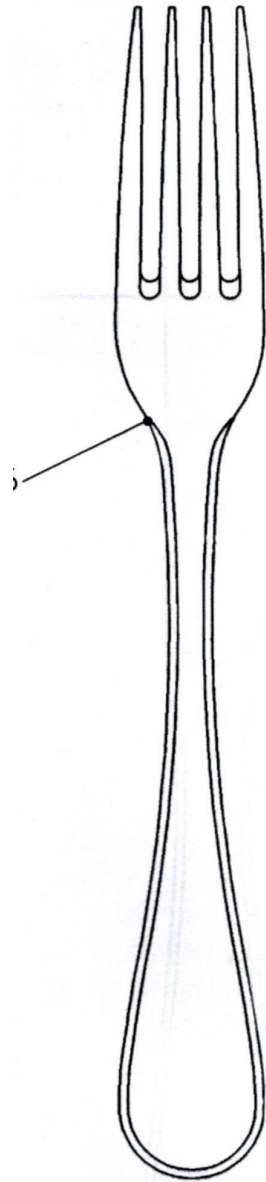

FIG. 11



FIG. 12

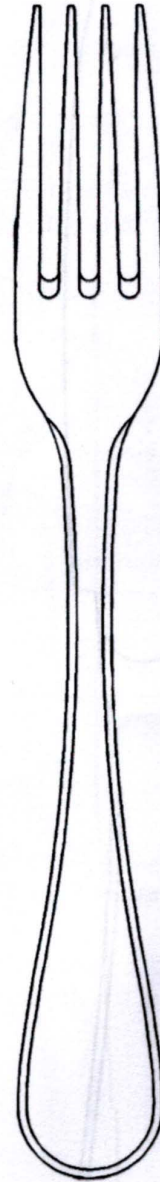

FIG. 07

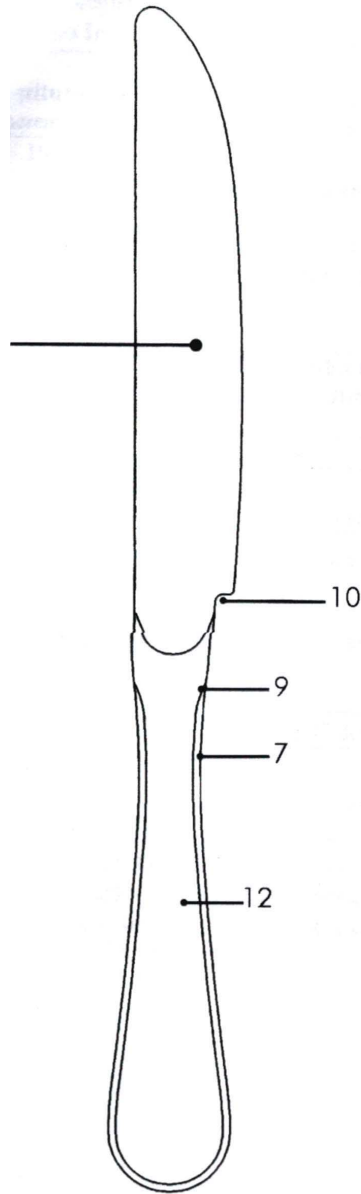
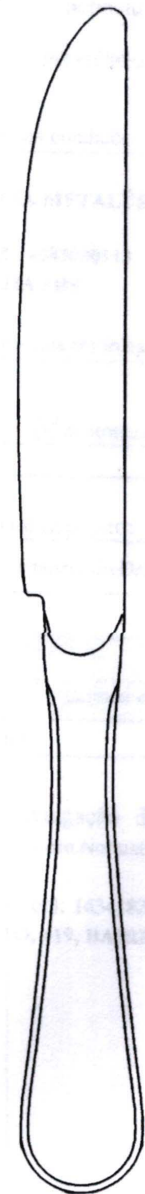

FIG. 08



FIG. 09



# Relatório Descritivo

Deverá ser objetivo e não deverá conter trechos explicativos que mencionem tipo de material utilizado na fabricação do objeto, dimensões (altura, comprimento, largura, etc.), detalhes construtivos, bem como detalhes internos, especificações técnicas e vantagens práticas.



Objeto

Registrável

e Não Registrável

# Parte Interna do Objeto

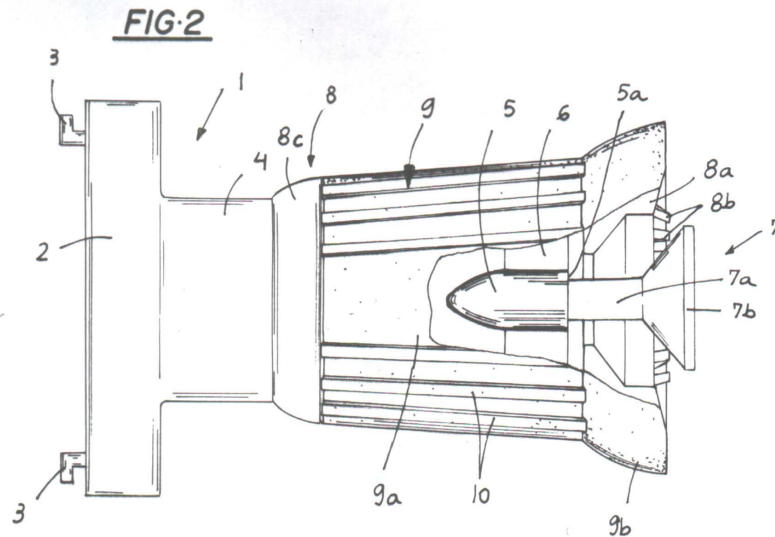
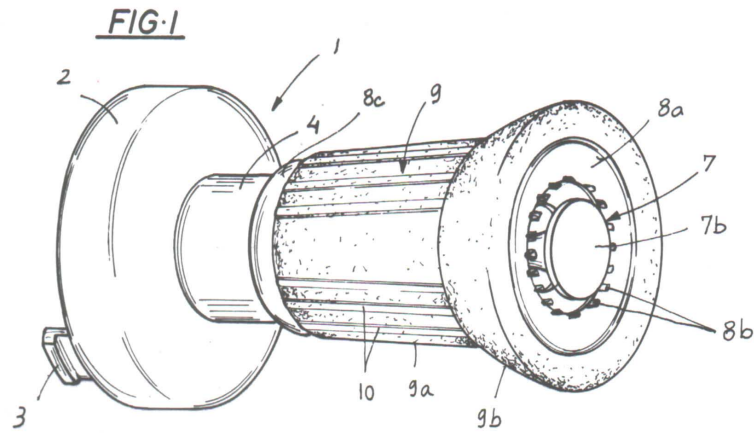

## Cor Única

“Dispositivo de Proteção Respiratória de Capacete, de Cor Vermelha”

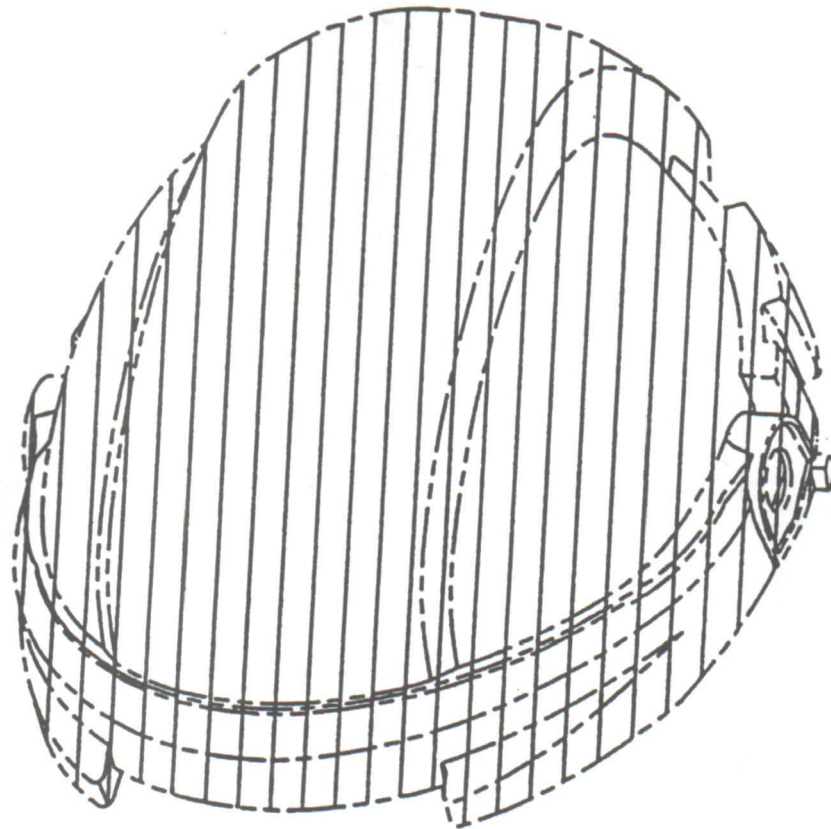

Não Registrável

“Cabeça com Cerdas  
para uma Escova de Dentes”

**FIG. 1**

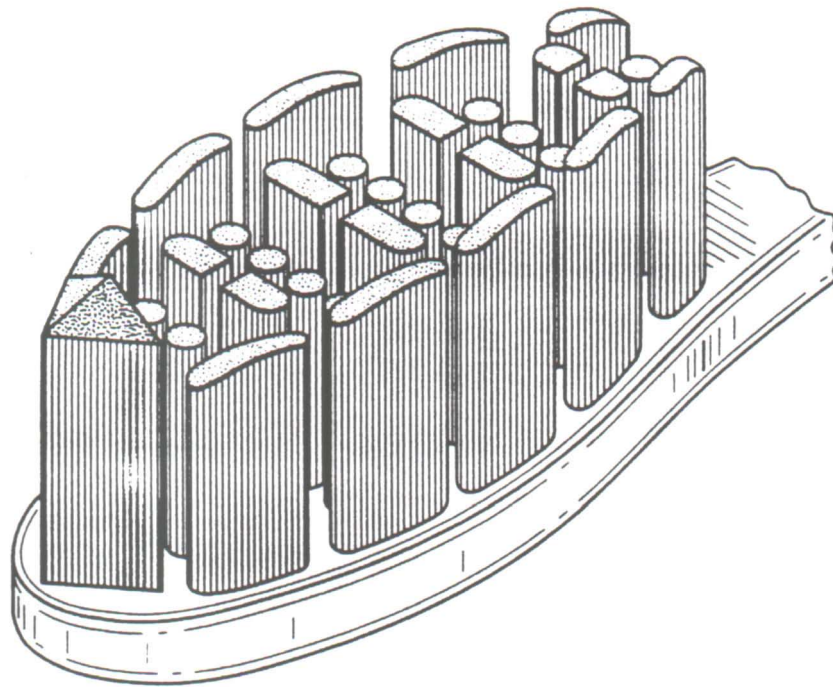

# Registrável

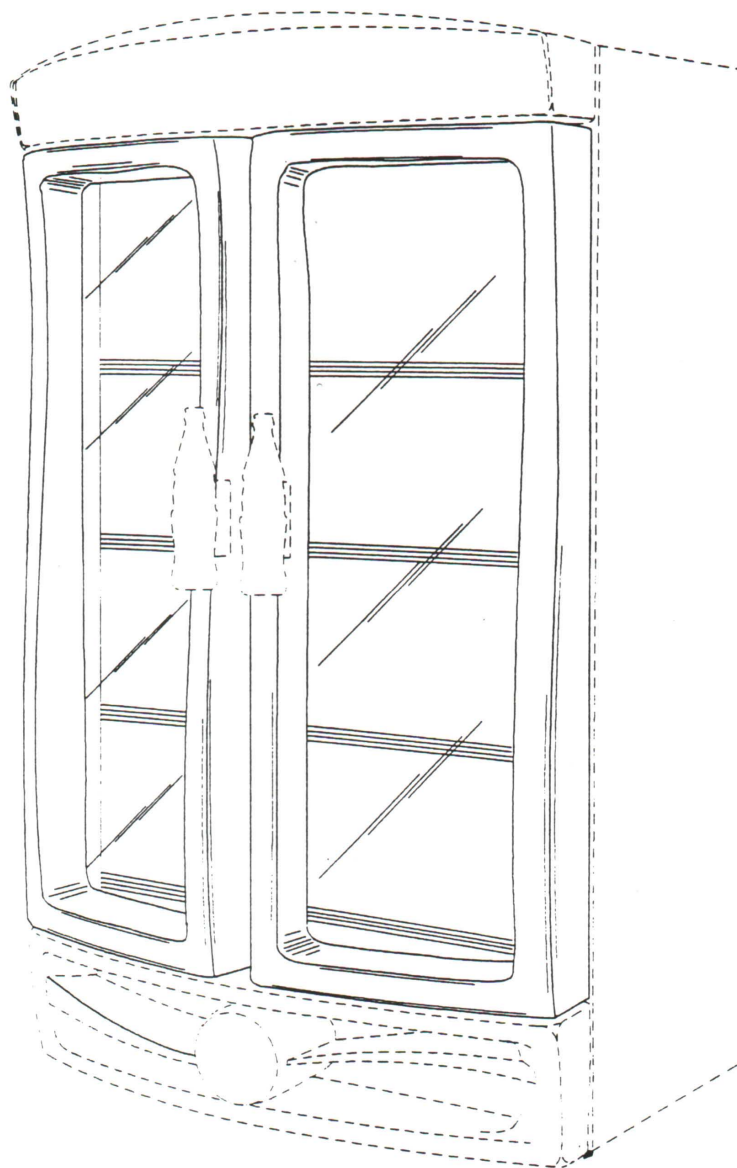



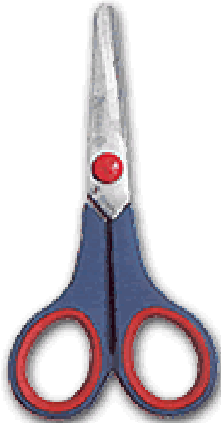

FIM

